

# MBN600GR12A

[Rated 600A/1200V, Single-pack type]

## FEATURES

- Low saturation voltage and high speed.
- Low turn-OFF switching loss.
- Low noise due to built-in free-wheeling diode.  
(Ultra Soft and Fast recovery Diode (USFD))
- High reliability structure.
- Isolated heat sink (terminals to base).

## CIRCUIT DIAGRAM

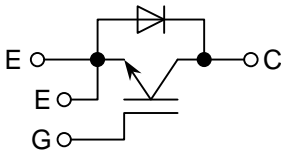

## OUTLINE DRAWING

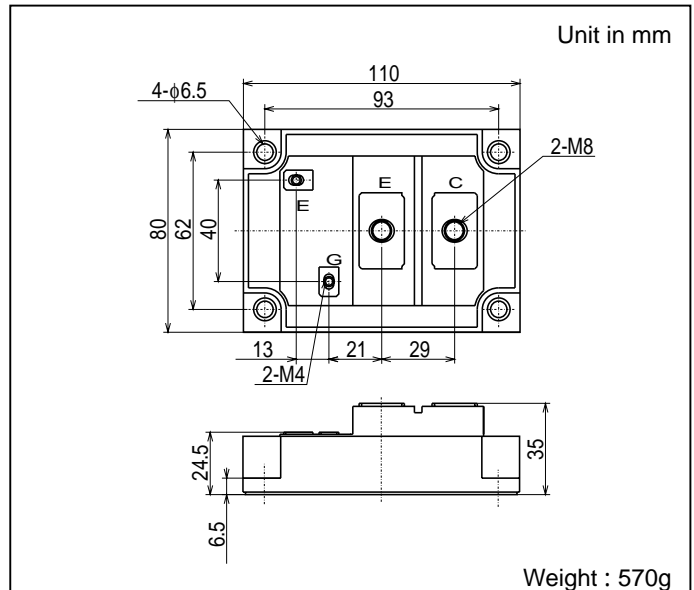

## ABSOLUTE MAXIMUM RATINGS (T<sub>c</sub>=25°C)

Item	Symbol	Unit	Value	
Collector-Emitter Voltage	V <sub>CEs</sub>	V	1200	
Gate-Emitter Voltage	V <sub>GES</sub>	V	±20	
Collector Current	DC	I <sub>C</sub>	600	
	1ms	I <sub>CP</sub>	1200	
Forward Current	DC	I <sub>F</sub>	600 <sup>*1</sup>	
	1ms	I <sub>FM</sub>	1200	
Collector Power Dissipation	P <sub>C</sub>	W	3790	
Junction Temperature	T <sub>j</sub>	°C	-40 ~ +150	
Storage Temperature	T <sub>stg</sub>	°C	-40 ~ +125	
Isolation Voltage	V <sub>iso</sub>	V <sub>RMS</sub>	2500(AC 1 minute)	
Screw Torque	Terminals(M4/M8)	—	N·m	1.37 / 7.84 <sup>*2</sup>
	Mounting			2.94 <sup>*3</sup>

Notes; \*1 : RMS current of diode ≤ 180 Arms

\*2 : Recommended value 1.18 / 7.35 N·m

\*3 : Recommended value 2.45 N·m

## CHARACTERISTICS (T<sub>c</sub>=25°C)

Item	Symbol	Unit	Min.	Typ.	Max.	Test Conditions	
Collector-Emitter Cut-Off Current	I <sub>CEs</sub>	mA	—	—	1.0	V <sub>CE</sub> =1200V, V <sub>GE</sub> =0V	
Gate-Emitter Leakage Current	I <sub>GES</sub>	nA	—	—	±500	V <sub>GE</sub> =±20V, V <sub>CE</sub> =0V	
Collector-Emitter Saturation Voltage	V <sub>CE(sat)</sub>	V	—	2.2	2.8	I <sub>C</sub> =600A, V <sub>GE</sub> =15V	
Gate-Emitter Threshold Voltage	V <sub>GE(To)</sub>	V	—	—	10	V <sub>CE</sub> =5V, I <sub>C</sub> =600mA	
Input Capacitance	C <sub>ies</sub>	pF	—	54000	—	V <sub>CE</sub> =10V, V <sub>GE</sub> =0V, f=1MHz	
Switching Times	Rise Time	t <sub>r</sub>	—	0.2	0.5	V <sub>CC</sub> =600V, I <sub>C</sub> =600A R <sub>G</sub> =2.2Ω <sup>*4</sup> V <sub>GE</sub> =±15V Inductive Load	
	Turn-On Time	t <sub>on</sub>	—	0.35	0.8		
	Fall Time	t <sub>f</sub>	—	0.15	0.35		
	Turn-Off Time	t <sub>off</sub>	—	0.75	1.2		
Peak Forward Voltage Drop	V <sub>FM</sub>	V	—	2.5	3.5	I <sub>F</sub> =600A, V <sub>GE</sub> =0V	
Reverse Recovery Time	t <sub>rr</sub>	μs	—	—	0.4	I <sub>F</sub> =600A, V <sub>GE</sub> =-10V, di/dt=600A/μs	
Thermal Impedance	IGBT	R <sub>th(j-c)</sub>	°C/W	—	—	0.033	Junction to case
	FWD	R <sub>th(j-c)</sub>					

Notes; \*4 : R<sub>G</sub> value is the test condition's value for decision of the switching times, not recommended value, please determine the suitable R<sub>G</sub> value after the measurement of switching waveforms (overshoot voltage, etc.) with appliance mounted.

Remark; For actual application, please confirm this spec. sheet is the newest revision.

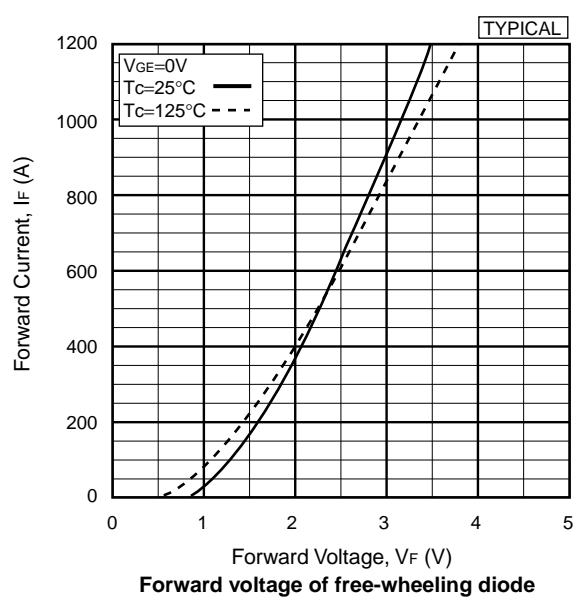
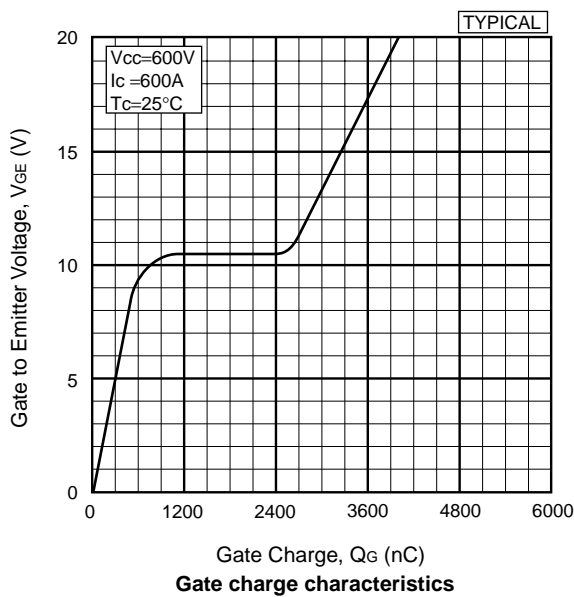
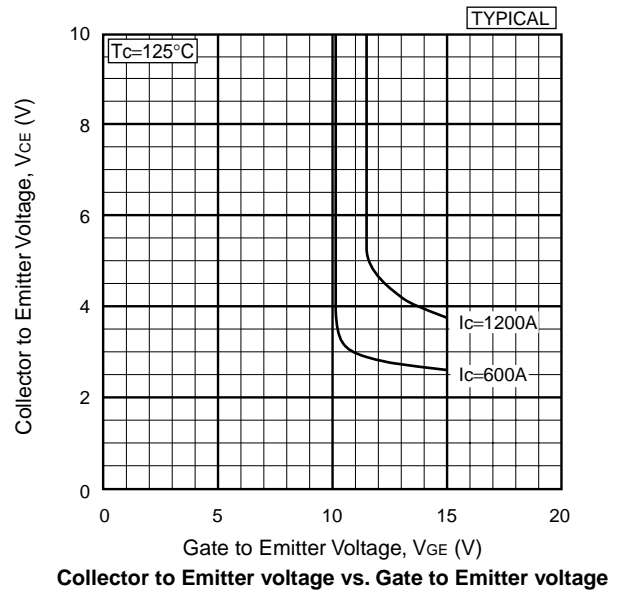
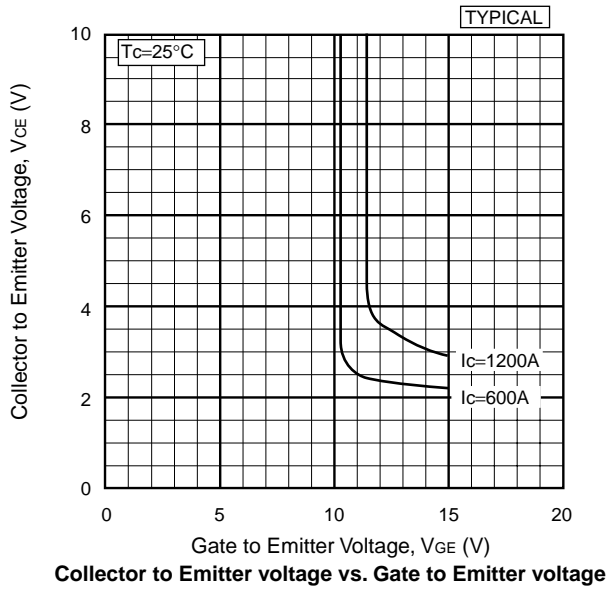
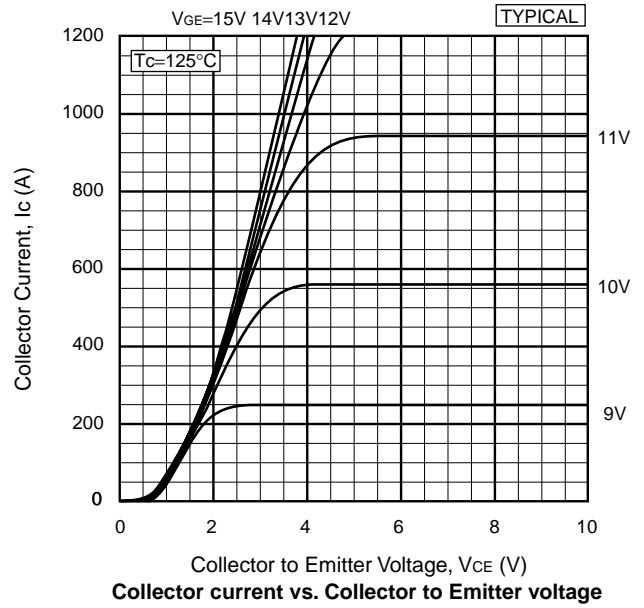
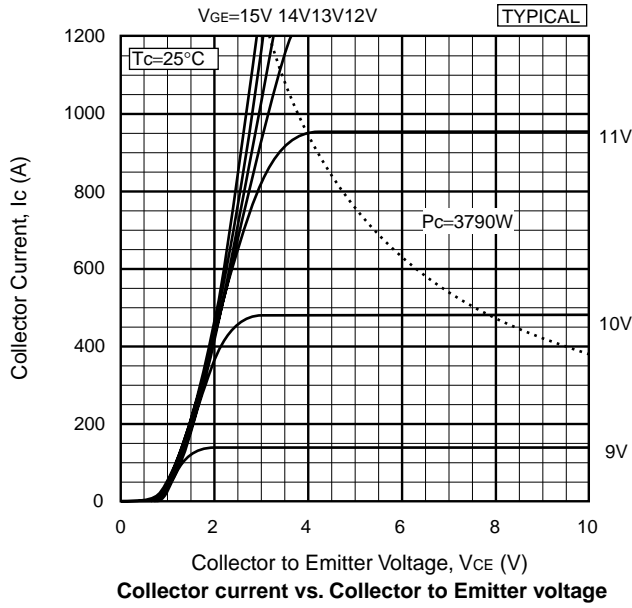

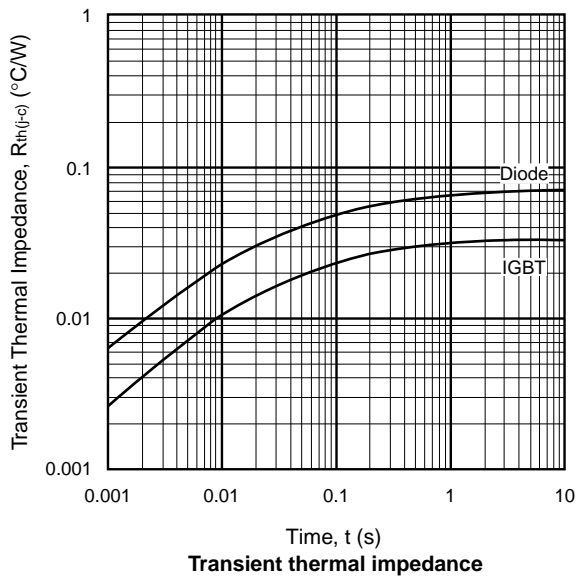
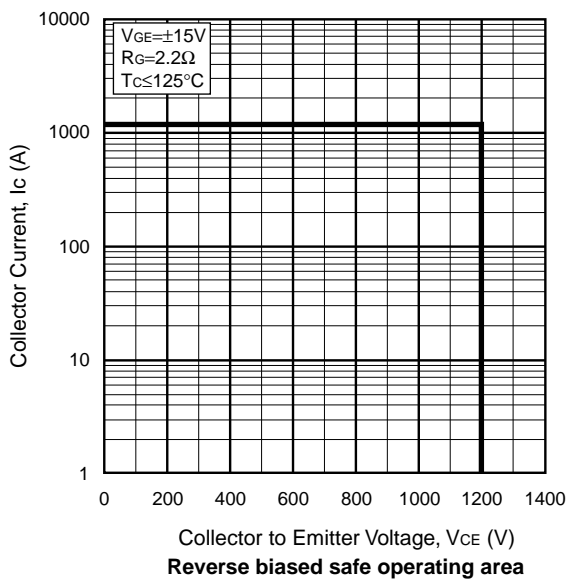
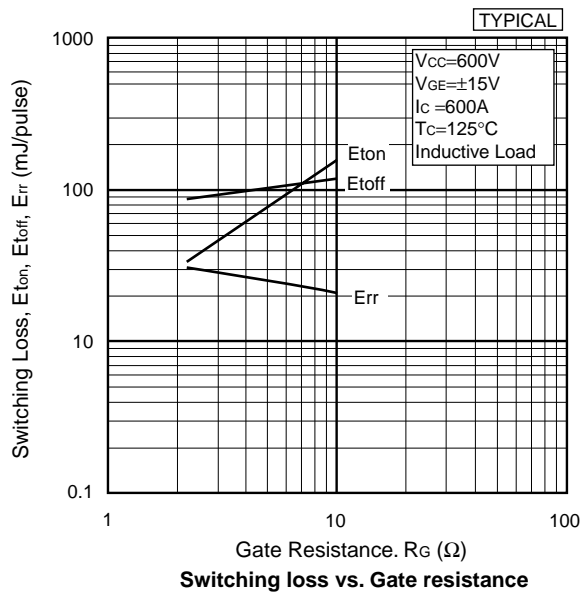
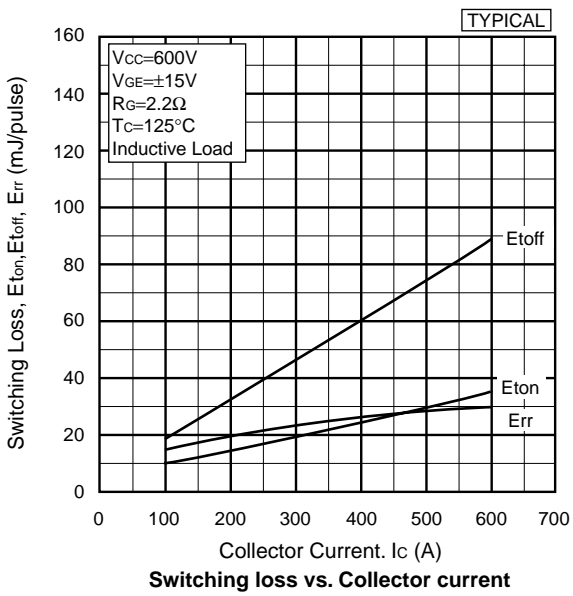
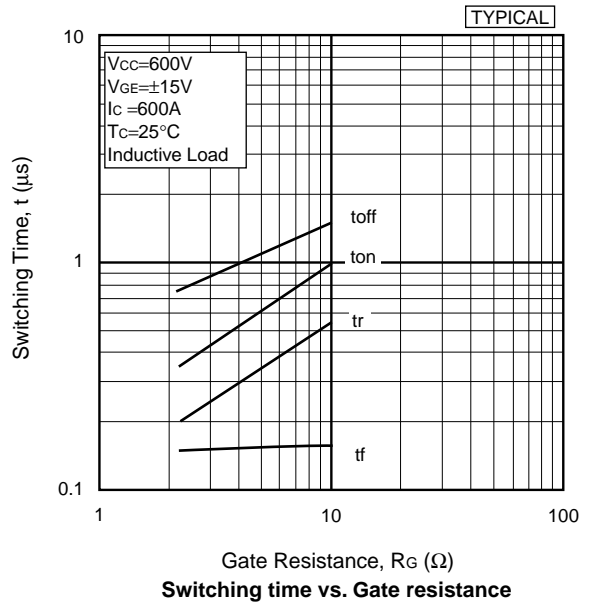
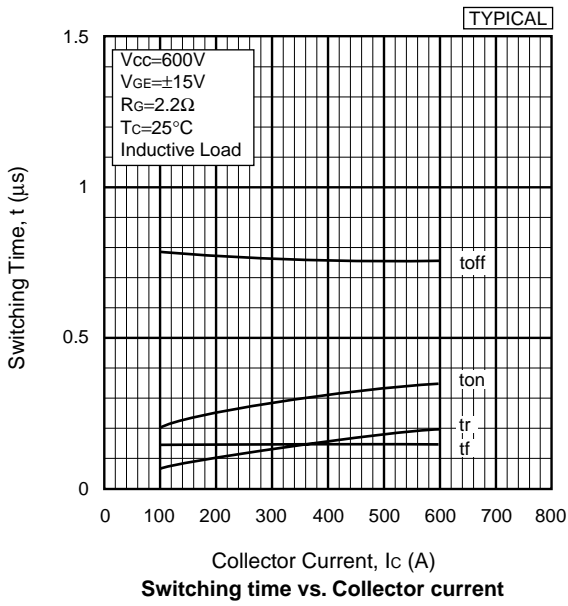

# HITACHI POWER SEMICONDUCTORS

## Notices

1. The information given herein, including the specifications and dimensions, is subject to change without prior notice to improve product characteristics. Before ordering, purchasers are advised to contact Hitachi sales department for the latest version of this data sheets.
2. Please be sure to read "Precautions for Safe Use and Notices" in the individual brochure before use.
3. In cases where extremely high reliability is required (such as use in nuclear power control, aerospace and aviation, traffic equipment, life-support-related medical equipment, fuel control equipment and various kinds of safety equipment), safety should be ensured by using semiconductor devices that feature assured safety or by means of users' fail-safe precautions or other arrangement. Or consult Hitachi's sales department staff.
4. In no event shall Hitachi be liable for any damages that may result from an accident or any other cause during operation of the user's units according to this data sheets. Hitachi assumes no responsibility for any intellectual property claims or any other problems that may result from applications of information, products or circuits described in this data sheets.
5. In no event shall Hitachi be liable for any failure in a semiconductor device or any secondary damage resulting from use at a value exceeding the absolute maximum rating.
6. No license is granted by this data sheets under any patents or other rights of any third party or Hitachi, Ltd.
7. This data sheets may not be reproduced or duplicated, in any form, in whole or in part , without the expressed written permission of Hitachi, Ltd.
8. The products (technologies) described in this data sheets are not to be provided to any party whose purpose in their application will hinder maintenance of international peace and safety not are they to be applied to that purpose by their direct purchasers or any third party. When exporting these products (technologies), the necessary procedures are to be taken in accordance with related laws and regulations.

- For inquiries relating to the products, please contact nearest overseas representatives which is located "Inquiry" portion on the top page of a home page.

Hitachi power semiconductor home page address <http://www.hitachi.co.jp/products/power/pse/>

**HITACHI**