

# DFG3A

## FEATURES

- For high speed switching.
- Diffused-junction. Glass passivated and encapsulated.

## OUTLINE DRAWING

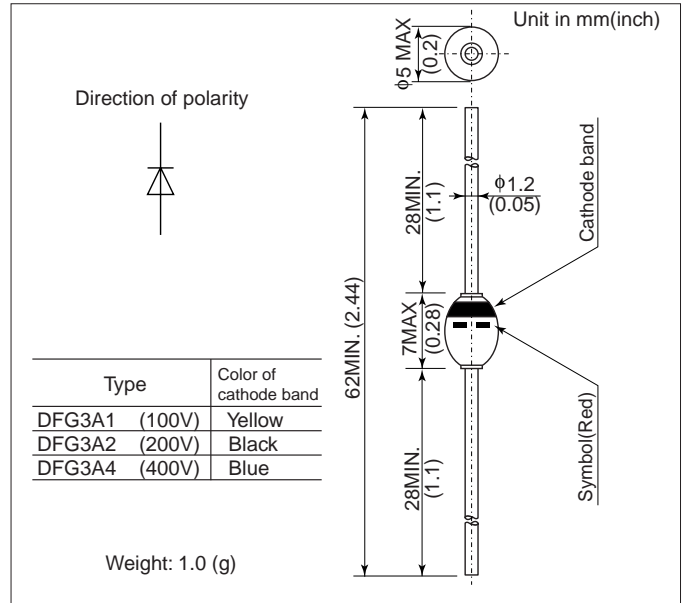

## ABSOLUTE MAXIMUM RATINGS

| Items                                 | Type             |                  | DFG3A1  | DFG3A2 | DFG3A4 |
|---------------------------------------|------------------|------------------|---|--------|--------|
| Repetitive Peak Reverse Voltage       | $V_{RRM}$        | V                | 100   | 200    | 400    |
| Average Forward Current               | $I_{F(AV)}$      | A                | 3.0 (Single-phase half sine wave 180° conduction )<br>TL = 60°C, Lead length = 10mm |        |        |
| Surge(Non-Repetitive) Forward Current | $I_{FSM}$        | A                | 70 ( Without PIV, 10ms conduction, T <sub>j</sub> = 150°C start )                   |        |        |
| I <sup>2</sup> t Limit Value          | I <sup>2</sup> t | A <sup>2</sup> s | 19.6 ( Time = 2 ~ 10ms, I = RMS value )   |        |        |
| Operating Junction Temperature        | T <sub>j</sub>   | °C               | -65 ~ +150  |        |        |
| Storage Temperature                   | T <sub>stg</sub> | °C               | -65 ~ +150  |        |        |

Notes (1) Lead mounting : Lead temperature 300°C max. to 3.2mm from body for 5sec. max..

(2) Mechanical strength : Bending 90°×2 cycles or 180°×1 cycle, Tensile 3kg, Twist 90°×1 cycle.

## CHARACTERISTICS(T<sub>L</sub>=25°C)

| Items                          | Symbols       | Units | Min. | Typ. | Max. | Test Conditions                                       |
|--------------------------------|---------------|-------|------|------|------|---|
| Peak Reverse Current           | $I_{RRM}$     | μA    | —    | 2.0  | 10   | Rated $V_{RRM}$                                       |
| Peak Forward Voltage           | $V_{FM}$      | V     | —    | —    | 1.3  | $I_{FM}=3.0A_p$ , Single-phase half sine wave 1 cycle |
| Reverse Recovery Time          | trr           | μs    | —    | —    | 0.1  | $I_F=0.5A$ , $I_{rp}=1.0A$ , 25% Recovery             |
| Steady State Thermal Impedance | $R_{th(j-a)}$ | °C/W  | —    | —    | 50   | Lead length = 10 mm                                   |
|                                | $R_{th(j-l)}$ |       |      |      | 20   |   |

# DFG3A

Forward characteristics

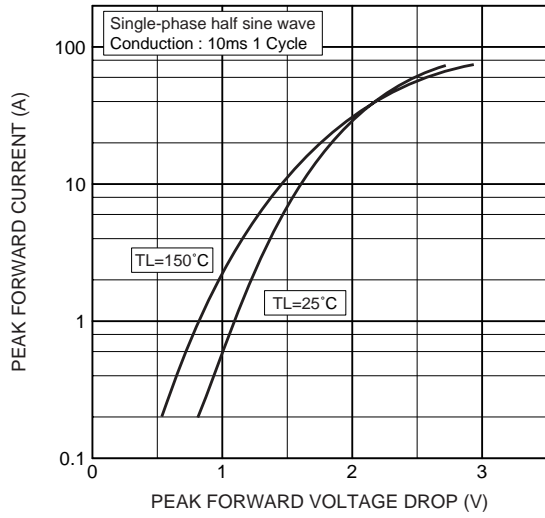

Max. average forward power dissipation (Resistive or inductive load)

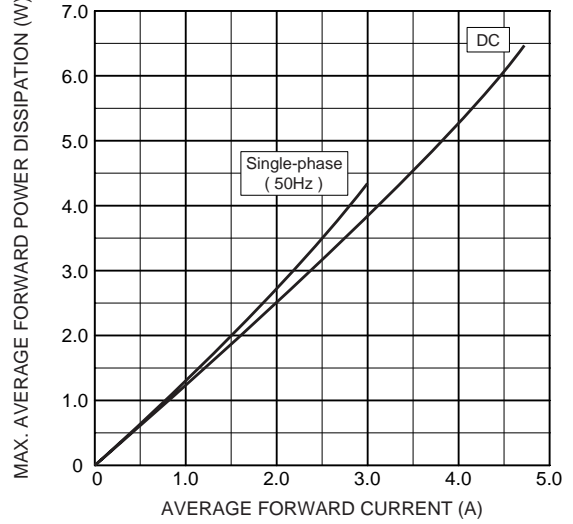

Max. allowable ambient temperature (Resistive or inductive load)

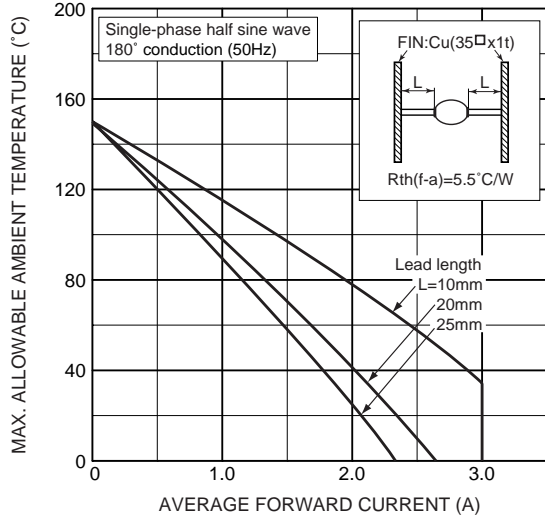

Max. allowable lead temperature (Resistive or inductive load)

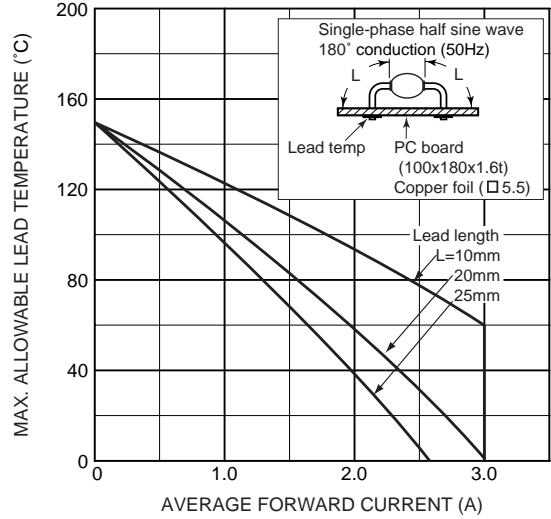

Surge forward current characteristic (Non-repetitive)

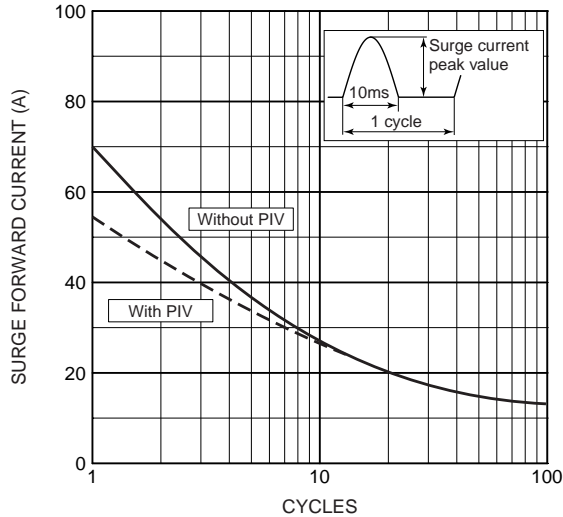

Typ. Reverse current vs. junction temperature

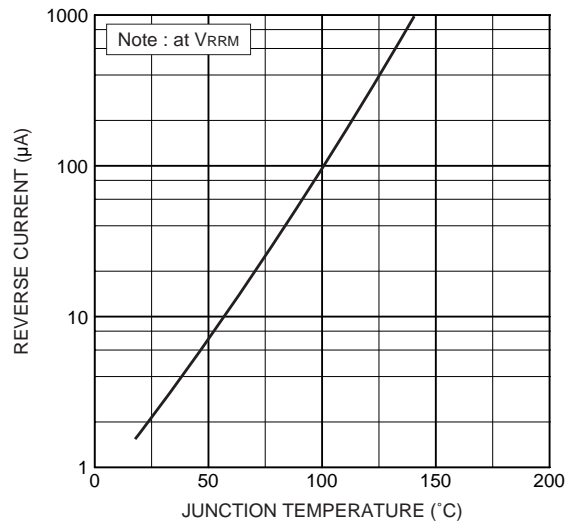

# DFG3A

## Steady state thermal impedance

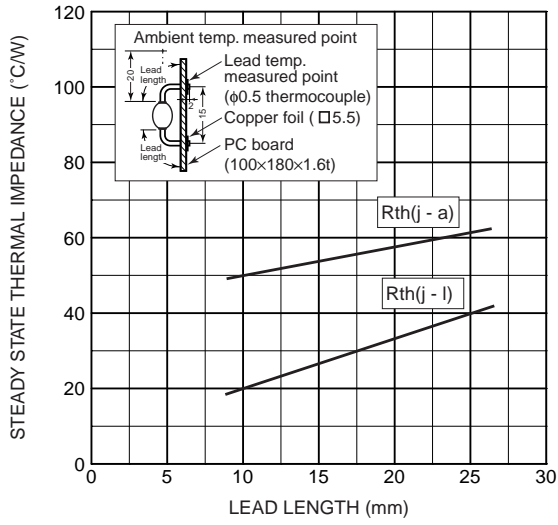

## Transient thermal impedance

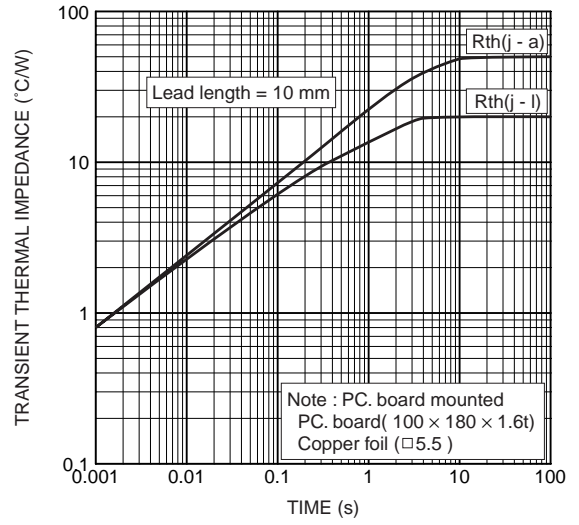

## Reverse recovery time ( $t_{rr}$ ) test circuit

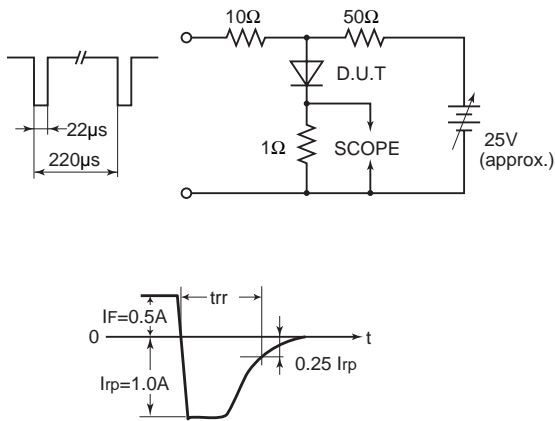

# HITACHI POWER SEMICONDUCTORS

## Notices

1. The information given herein, including the specifications and dimensions, is subject to change without prior notice to improve product characteristics. Before ordering, purchasers are advised to contact Hitachi sales department for the latest version of this data sheets.
2. Please be sure to read "Precautions for Safe Use and Notices" in the individual brochure before use.
3. In cases where extremely high reliability is required (such as use in nuclear power control, aerospace and aviation, traffic equipment, life-support-related medical equipment, fuel control equipment and various kinds of safety equipment), safety should be ensured by using semiconductor devices that feature assured safety or by means of users' fail-safe precautions or other arrangement. Or consult Hitachi's sales department staff.
4. In no event shall Hitachi be liable for any damages that may result from an accident or any other cause during operation of the user's units according to this data sheets. Hitachi assumes no responsibility for any intellectual property claims or any other problems that may result from applications of information, products or circuits described in this data sheets.
5. In no event shall Hitachi be liable for any failure in a semiconductor device or any secondary damage resulting from use at a value exceeding the absolute maximum rating.
6. No license is granted by this data sheets under any patents or other rights of any third party or Hitachi, Ltd.
7. This data sheets may not be reproduced or duplicated, in any form, in whole or in part , without the expressed written permission of Hitachi, Ltd.
8. The products (technologies) described in this data sheets are not to be provided to any party whose purpose in their application will hinder maintenance of international peace and safety not are they to be applied to that purpose by their direct purchasers or any third party. When exporting these products (technologies), the necessary procedures are to be taken in accordance with related laws and regulations.

- For inquiries relating to the products, please contact nearest overseas representatives which is located "Inquiry" portion on the top page of a home page.

Hitachi power semiconductor home page address <http://www.hitachi.co.jp/products/power/pse/>

**HITACHI**